

Scaffold Depot

MANUFACTURER DIRECT 

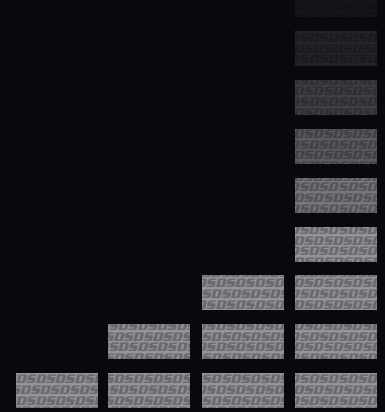

PRODUCT CATALOG

WWW.SCAFFOLDDEPOT.COM

TABLE OF CONTENTS

ABOUT US	3
CUSTOM ORDERS	4-5
ERECTION PROCEDURE	6
RING SYSTEM	8-9
<i>LADDERS & ACCESSORIES</i>	<i>10</i>
ALUMINUM / PLYWOOD DECKS	12
STEEL PLANKS	13
WORK PLATFORMS	14
TLFI COUPLERS	16-17
ALUMINUM BEAM & TUBE	18
ACCESS FRAMES	20-21
ACCESS STAIRS	22
ACCESSORIES	24-27
<i>PINS & TIES</i>	<i>24</i>
<i>CROSSBRACES & GOOSERS</i>	<i>25</i>
<i>SIDE BRACKETS & OUTRIGGERS</i>	<i>26</i>
<i>CASTERS & SCREWJACKS</i>	<i>27</i>
TOE BOARDS	28
MULTI-FUNCTION SCAFFOLD	29
SHORING	30
CONTACT US	31

ABOUT US

Scaffold Depot



Scaffold Depot offers a wide range of products and services for industrial capital projects, maintenance and new construction projects across North America.



Of primary importance in any project is safety. Working directly with our customers we have developed a commitment to provide safe, durable, quality products that meet all applicable industry regulations and standards.

We strive to develop new procedures to increase manufacturing, distribution and marketing efficiencies, ensuring Scaffold Depot is able to offer competitive pricing while maintaining the high standards demanded by our customers.

Our Surrey, British Columbia facility is capable of manufacturing Steel Planks, Aluminum & Plywood Decks, and Staircase Systems for general and custom projects on an expedient time-line.

Scaffold Depot has entered into a cooperative agreement with an ISO registered manufacturing partner to develop a complete line of Wedge Couplers with world wide exclusivity.

We offer a complete line of Ring System that is used extensively in the refinery & petrochemical industries, pulp & paper mills, power stations and construction projects.



Scaffold Depot is driven to ensure complete customer satisfaction, every time, and maintain a company culture that encourages continuous improvement.

Please feel free to contact us to learn more about how we can assist your organization 1-888-595-6111



CSA

ANSI



OHSA

CUSTOM ORDERS

Scaffold Depot – Manufacturer Direct, is able to meet any customer's custom scaffolding requirements. Our ability to manufacture custom length Rhinobuilt Steel Planks, Aluminum Plywood Decks, Crossbraces, and Guardrails, ensures the correct component for every application. Modify frame lock positions, hole and hook placement, tube diameter, and finish, to suit your exact needs.

Planks & Decks

Scaffold Depot Manufacturer Direct supplies a full line of pre-galvanized Steel Scaffold Planks and work platforms to the Industrial and Commercial sectors. Proudly manufactured in Surrey, BC, Scaffold Depot's automated facility is capable of roll forming 9" wide steel planks, assembled with bolt-on, or welded hooks.

A large inventory of raw materials allows Scaffold Depot to manufacture a variety of custom sizes and styles on short notice. Stock sizes are available immediately upon request. All design specifications, materials, and finished products meet applicable industry standards.



Our Surrey, British Columbia facility is capable of manufacturing Steel Planks, Aluminum & Plywood Decks, and Staircase Systems for general and custom projects on an expedient time-line.

Scaffold Depot offers manufacturer direct, container load quantities and pricing, meticulous, professional service, and the highest quality production standards.

Worldwide Shipping



Scaffold Depot

Coupling Pins



Available with no collar, 1/8" collar, or 1" collar, coupling pins can be ordered in a variety of Outside Diameters to suit various frame tube dimensions.

Frame Locks

Custom lock configurations and colours.

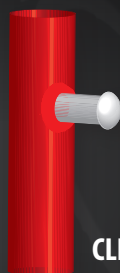

CLIP LOCK

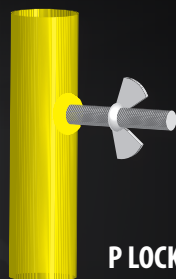

P LOCK

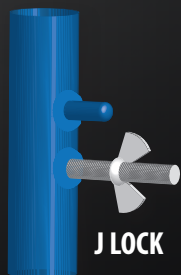

J LOCK

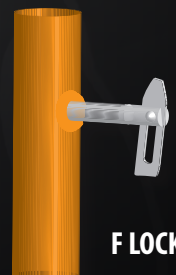

F LOCK

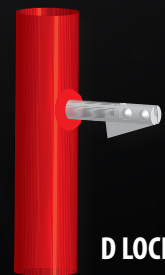

D LOCK



V LOCK

Frames

Choose from all of the industry standard frame styles, available in a variety of tube diameters, with heavy-duty galvanized finish or choose custom powder coating colours. Lock quantities, style and placement can all be custom selected to meet your exact application requirements.

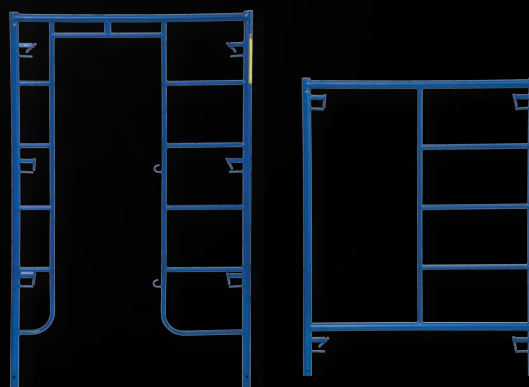

ERECTIONPROCEDURE

Scaffolding Regulations and Manufacturers Recommendations

The following information is intended to ensure erectors construct scaffolding safely and efficiently. Even a correctly constructed scaffold can be involved in an accident if the correct safety precautions are not taken in its use. Serious injury or death can result from failure to familiarize yourself and comply with all applicable safety requirements, and safety guidelines before erecting, using or disassembling scaffold. For more complex structures, always consult your engineer or technical services department. Additional bracing or tie-ins are often required depending on intended loads to be supported by the scaffolding, wind loads, and flying of towers. Scaffold design must always include analysis of load carrying members by properly qualified personnel.

Scaffolding regulations may vary depending on your area. Always ensure scaffold erections comply with any Federal, Provincial, State, or local requirements.

Be aware of all safety guidelines relevant to scaffolding components and site specifications and regulations.

Confirm all loads that are to be imposed on the scaffold.

Ensure scaffold construction will support all intended loads used in the erection of the scaffolding.

Ensure that all vertical loads on the scaffold can be supported by the ground and that all horizontal loads can be taken by anchors and supporting structure.

Be sure to check position of the scaffolding in relation to surroundings or hazards.

Erection, altering, or dismantling of scaffold should only be carried out by or under the supervision of a Competent Person, who is familiar with the component specifications and workplace safety regulations.

All components must be inspected for damage or wear prior to set up. Damaged materials must never be used in any scaffolding erection.

Compensate for uneven ground by using screwjacks. All scaffold legs require the use of a base plate and mudsill or other adequate firm foundation. Do not use unstable objects such as blocks, loose bricks, and similar objects or materials.

Safety equipment, including safety glasses and hardhats, should be worn by all persons erecting, moving, or disassembling scaffold.

Work Platforms must be fully decked with platform units in good, sound condition. Platform units may be individual scaffold grade wood planks, fabricated plank, fabricated scaffold decks or fabricated scaffold platforms. Secure platform units to scaffold to prevent uplift caused by high winds or other job site conditions. Use latches, if supplied by platform manufacturer, or other suitable means.

Guardrail Systems must be used on all open sides and ends of scaffold platforms. Both top and mid-rails are required. Local codes specify minimum heights where guardrails are required. Use at lower heights where falls could cause injury.

Toe boards must be installed whenever people are required to work or pass under a scaffold platform. When materials are to be stacked higher than the toe board, screening is required from the toe board or platform to the top guardrail.

Frame connections must be secured in place. Connecting devices shall be installed progressively as the erection proceeds. Scaffold Frames must be fastened together at coupling pins where there is a possibility of uplift, and when casters are used to create a rolling scaffold.

Access must be provided to all work platforms. Do not climb any scaffold component that is not specifically designed for that purpose.

Never extend working heights by standing on ladders or other materials on scaffold platforms.

Always inspect the completed scaffold assembly prior to use. Ensure all ties are in place, work platforms are level, guardrails are in place, and safe access is provided.

Anchors

Tie-ins are used to increase the global stability of the scaffold, stopping it from turning over, and the local stability, reducing the length of the verticals.

Quantities and locations of anchors will vary depending on load and structural conditions. The following are general guidelines indicating minimum requirements and are not all inclusive. Always consult with your engineer or technical services department when designing scaffolds with unique configurations or load capacities.

A scaffold must always be secured when the height of the scaffold exceeds 3 times the minimum base width. Base dimension is measured at centerline of the vertical standards or frame legs.

Placement of anchors (Tie-ins):

Ties must be installed as the erection progresses and not removed until scaffold is dismantled to that height.

- The first tie-in must be placed at a maximum height of 3 times the minimum base dimension.
- Intermediate tie-ins must not exceed 3 vertical lifts. Always follow provincial or state regulations.
- The uppermost tie must be placed within 1 lift of the top of the scaffold, regardless of proximity to nearest intermediate tie.
- Structures must be tied at each end, and at intervals of no more than 6M (20') along the horizontal.

Ties must be placed as near as possible to horizontal members.

Outriggers may be used to increase the minimum base dimension of a scaffold Tower. **WARNING** – The resulting base dimension may no longer be the minimum or limiting base dimension. If used on a free standing tower, outriggers must be installed on both sides.

Inspect your scaffold prior to each use to ensure that the assembly has not been altered and is safe for your use.

Safety must always come first!!

Serious injury or death can result from the failure to familiarize yourself with, and comply with all applicable safety requirements and regulations when erecting, using, or dismantling scaffolding. Understanding and following these safety guidelines will increase your personal safety and the safety of your fellow workers.

Component weights and load specifications are available from Scaffold Depot.



SDRINGSYSTEM
SCAFFOLD

RINGSYSTEM//

Ring System Scaffold

Our complete line of Ring System is used extensively in the refinery & petrochemical industries, pulp & paper mills, power stations and new construction.

Standards

MODEL	DESCRIPTION	WEIGHT*
SDBSC	Base Collar	**4 lbs.
SDSTD.5M	0.5M Standard	6.75 lbs.
SDSTD1M	1M Standard	12 lbs.
SDSTD1.5M	1.5M Standard	17.5 lbs.
SDSTD2M	2M Standard	22.5 lbs.
SDSTD3M	3M Standard	33.5 lbs.

*Weight includes 1 coupling pin and hardware
**Weight does not include coupling pin

Hot-dipped galvanized standards are available in a variety of lengths, from 0.5M – 3M, and feature multiple rosettes, allowing for adaptability in a multitude of applications.

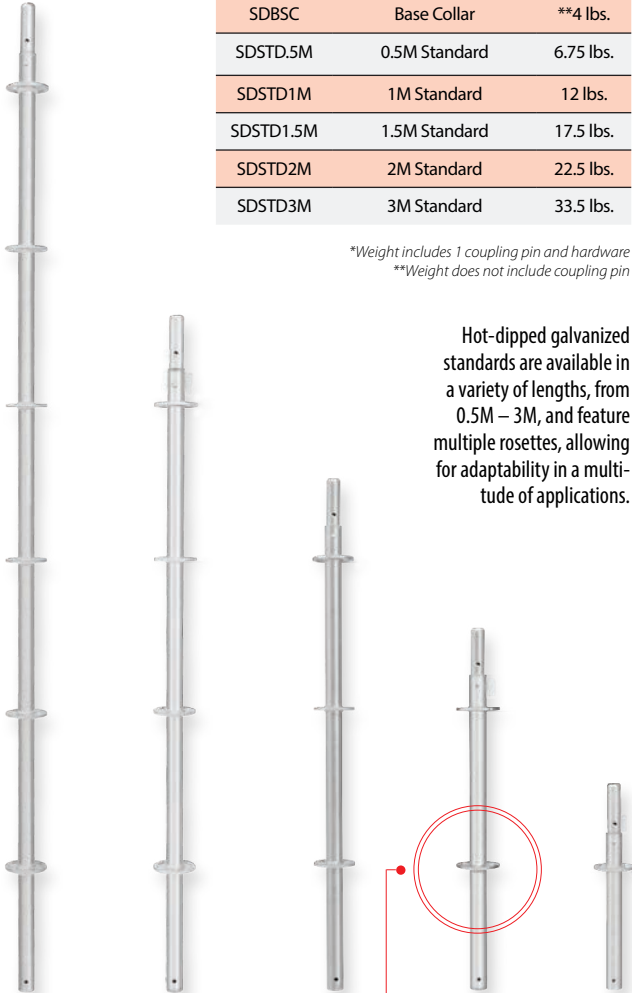

Bay Braces

Bay Braces feature wedge locking system, allowing quick, secure support, diagonally across individual bays. Available in a variety of lengths, and finished in corrosion resistant, hot-dipped galvanizing, Bay Braces ensure erections are laterally stable.



MODEL	EFFECTIVE WIDTH	WEIGHT
SDBB1.15M	1.15M Bay Brace	22.5 lbs.
SDBB1.57M	1.57M Bay Brace	24.5 lbs.
SDBB2.13M	2.13M Bay Brace	27.5 lbs.
SDBB8	8' Bay Brace	29.25 lbs.
SDBB3.05M	3.05M Bay Brace	33.25 lbs.

*Width determined by distance center to center of standards

Mid-Transoms



MODEL	EFFECTIVE WIDTH	WEIGHT
SDMT.65M	0.65M Mid Transom	6.5 lbs.
SDMT1.15M	1.15M Mid Transom	11.5 lbs.
SDMT1.57M	1.57M Mid Transom	13.75 lbs.
SDMT2.13M	2.13M Mid Transom	19.5 lbs.

*Width determined by distance center to center of standards



TAKE A LOOK 

Rosettes offer up to 8 connections, 4 at right angles, and 4 variables.

System Scaffold Features

- Versatile and quick to install
- Durable, rust resistant Galvanized finish
- High Strength components adapt to any application
- Compatible with our full line of accessories and stair components

RINGSYSTEM//&STAIRCOMPONENTS

Ring System Scaffold

Compatible with Tube and Clamp Scaffold. Scaffold Depot's line of Ring System Scaffold allows for fast, straight forward set-up, and is complimented by a full range of accessories, including Toe boards, and Stairs.

Single & Double Ledgers



Horizontal Ledgers double as guardrails and bracing, and feature wedge locking system, providing fast, secure connections, without requiring additional couplers. Heavy-duty, hot-dipped galvanized finish ensures low maintenance, durable components.

Trussed Ledgers



MODEL	EFFECTIVE WIDTH	WEIGHT
SDLED.65M	0.65M Ledger	7.5 lbs.
SDLED.88M	0.88M Ledger	9.5 lbs.
SDLED3'6"	3'6" Stair Ledger	11 lbs.
SDLED1.15M	1.15M Ledger	11.75 lbs.
SDLED4	4' Ledger	12.25 lbs.
SDLED1.57M	1.57M Ledger	15.15 lbs.
SDLED2.13M	2.13M Ledger	16.25 lbs.
SDLED8	8' Ledger	19.25 lbs.
SDLED3.05M	3.05M Ledger	22.75 lbs.

* Width determined by distance center to center of standards

MODEL	EFFECTIVE WIDTH	WEIGHT
SDTL2.13M	2.13M Double Ledger	31 lbs.
SDTL8	8' Double Ledger	37 lbs.
SDTL3.05M	3.05M Double Ledger	53.5 lbs.

* Width determined by distance center to center of standards

Lattice Girder

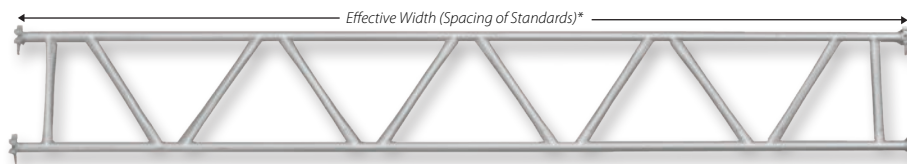

MODEL	EFFECTIVE WIDTH	WEIGHT
SDLG4.26M	Lattice Girder 4.26M (14')	99 lbs.
SDLG5.18M	Lattice Girder 5.18M (17')	119 lbs.
SDLG6.39M	Lattice Girder 6.39M (21')	144 lbs.
SDLG8.52M	Lattice Girder 8.52M (28')	195 lbs.

* Width determined by distance center to center of standards

Ring System Stair Components

32" Stair Tread

Each stair section requires 10 treads for assembly. Scaffold Depot's 32" Wide Stair Tread features corrugated step for increased traction, and hot-dipped galvanized finish, ensuring long-life, and low maintenance. Gravity Fit securing system allows for fast, tool-less installation, while creating a secure connection.



7' Stair Stringer

Hot-dipped Galvanized 7' Stair Stringers utilize mounting pegs on both sides, to eliminate requiring different parts for left and right sides. Hot-dipped Galvanized finish ensures low maintenance, durable components.



LADDERS & ACCESSORIES //

Access Ladders

Steel Access Ladders are available in 3', 5' and 10' lengths, in Powder coated or Hot-dipped Galvanized finish. Scaffold Depot also manufactures Aluminum ladders, available in custom sizes, and with the option of regular or aggressive grip rungs.

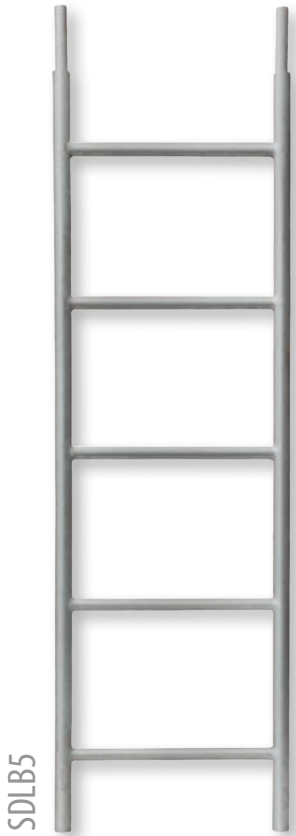

Starter brackets feature TLFI wedge clamp for fast, secure erection.

Available finishes:



MODEL	DESCRIPTION	WEIGHT
SDLB3	3' Steel Ladder	9.5 lbs.
SDLB5	5' Steel Ladder	15.5 lbs.
SDL10	10' Steel Ladder (1.9" O.D.)	58 lbs.
SDSBC	Starter Bracket w/clamp	6.5 lbs.

*Width measurement based on center to center of leg tube

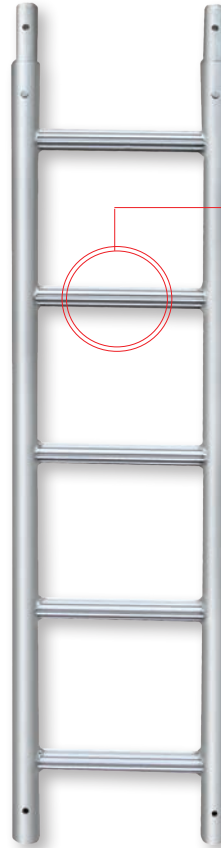

Aluminum ladders are manufactured using high tensile, 1.9" O.D. Aluminum tubing, compatible with TLFI Right Angle and Swivel Couplers.



Aluminum Ladder rungs come in two non-slip options: aggressive tread and regular tread.

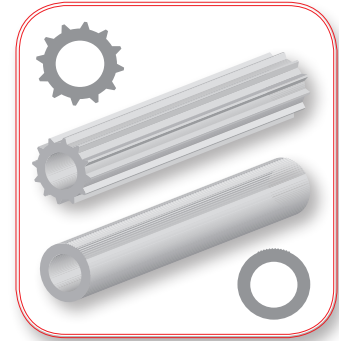

Available finishes:



System Accessories

BASE COLLAR

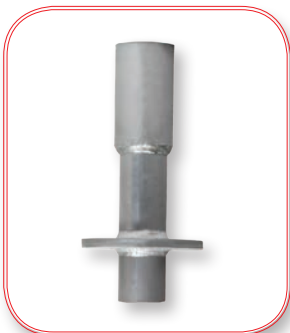

SDSBC

The base collar with single rosette is placed onto the screwjack prior to the standards, and allows for an easy base out of the scaffold.

SIDE BRACKETS

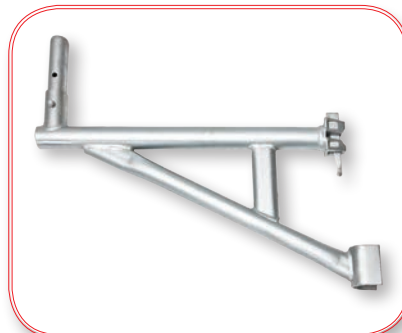

MODEL	DESCRIPTION	WEIGHT
SDSBC	Base Collar	4 lbs.
SDSB.65	0.65M Side Bracket	15 lbs.
SDSB1.05	1.05M Side Bracket	22 lbs.

SDSB.65

Side brackets can be used to expand the working platform off of the side of the scaffold.



Scaffold Depot Manufacture Direct

supplies a full line of pre-galvanized Steel Scaffold Planks and work platforms to the Industrial and Commercial sectors. Proudly manufactured in Surrey, B.C., Scaffold Depot's automated facility is capable of roll forming 9" wide steel planks, assembled with bolt-on, or welded hooks.

A large inventory of raw materials allows Scaffold Depot to manufacture a variety of custom sizes and styles on short notice. Stock sizes are available immediately upon request. All designs specifications, materials, and finished products meet applicable industry standards.



WORK PLATFORMS

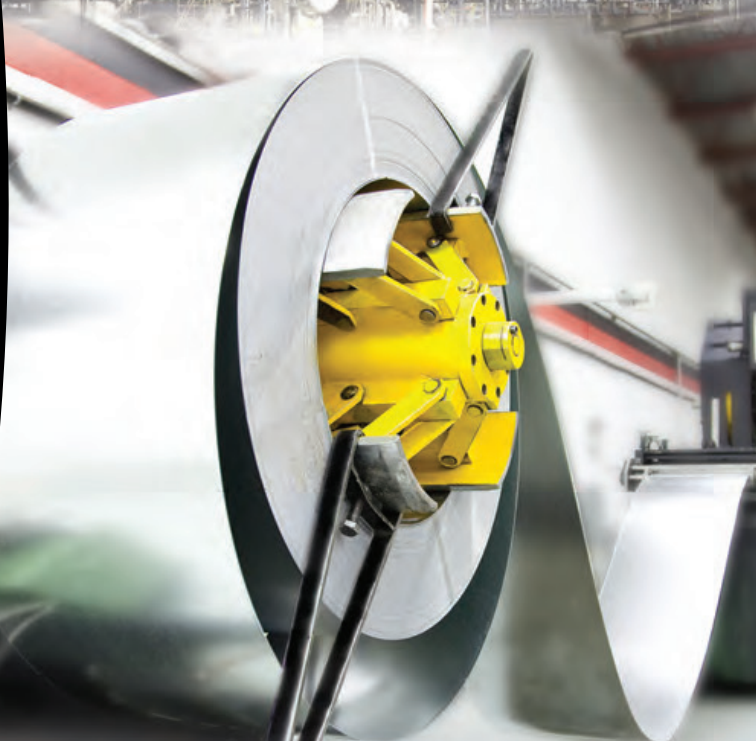

SCAFFOLD DECKS // PLYWOOD

Manufactured in North America,

Scaffold Depot's line of Scaffold Decks offer heavy-duty Aluminum I-beam side rails, one piece hooks, and Windlatch securing system.

SD1019

SD719



Scaffold Depot's Quality Assurance Program implements Component Inspection, In-process Inspections, and Final Product Inspections, to ensure only the highest quality, strongest, safest product. All sizes feature 1-piece plywood work surface, reducing warping and tripping hazards, and 6061 High Tensile Aluminum side rails and rungs.

MODEL	DESCRIPTION	WEIGHT
SD1065	3'6" x 19" Alum/Ply deck	17 lbs.
SD115	1.15m x 19" Alum/Ply Deck (3'6")	19 lbs.
SD519	5' x 19" Alum/Ply Deck	24 lbs.
SD524	5' x 24" Alum/Ply Deck	26 lbs.
SD157	1.57m x 19" Alum/Ply Deck (5'2")	26 lbs.
SD719	7' x 19" Alum/Ply Deck	31 lbs.
SD724	7' x 24" Alum/Ply Deck	34 lbs.
SD819	8' x 19" Alum/Ply Deck	34 lbs.
SD824	8' x 24" Alum/Ply Deck	39 lbs.
SD1019	10' x 19" Alum/Ply Deck	45 lbs.
SD1024	10' x 24" Alum/Ply Deck	52 lbs.
SLHD1024	10' x 24" Ladder Hatch Deck	75 lbs.

Custom sizes available

Our Plywood Scaffold Deck comes in a wide variety of custom lengths

Decks less than 8' in length utilize a smaller side rail and center rung, but still have the same load capacity of larger decks. Requiring only 3 rungs reduces weight, in turn reducing stress on employees and scaffold components.

ANATOMY OF A HEAVY DUTY DECK



Aluminum Windlatch secures decks in even the windiest of conditions.

All side rails, rungs and hooks manufactured from 6061, high tensile aluminum. Wrap around design protects edges of wood work surface, preventing warping and increasing life span.

Scaffold Deck Features

- Offset hooks
- Full Traceability of all components
- One piece plywood work surface
- Meets CSA and OSHA requirements

Aluminum I beam rungs add strength and rigidity.

STEEL PLANKS // RHINO BUILT

Rhino Built Steel Planks

Scaffold Depot's lines of Rhino Built Steel Scaffold Planks are available in a variety of styles and sizes, making them the ideal solution to your work platform requirements. Proudly manufactured in North America, Rhino Built planks meet all applicable industry standards.

Corrugated work surface helps prevent slipping



Our Rhino Built Line

The Rhino Built line of Scaffold Planks is proudly manufactured in North America, using only the highest quality components, and adhering to strict quality control guidelines. Compliance with extensive quality assurance

procedures and full traceability of all components ensures only the highest level of build quality and durability. Available in stock and custom lengths, the Rhino Built line incorporates a custom profile, increasing strength and structural stability.

IMPERIAL LENGTHS	METRIC	WEIGHT
2'	0.610	11.2 lbs.
2' 2"	0.650	11.82 lbs.
3'	0.914	14.9 lbs.
3' 6"	1.067	16.75 lbs.
3' 10"	1.150	17.5 lbs.
4'	1.219	18.6 lbs.
5'	1.524	22.3 lbs.
5' 2"	1.570	23 lbs.
6'	1.829	26 lbs.
7'	2.134	30 lbs.
8'	2.438	33.4 lbs.
9'	2.743	37.2 lbs.
10'	3.048	42 lbs.

SD SERIES

SD Series Rhino Built Steel Scaffold planks feature symmetrical punched hole pattern corrugated work surface, offset hooks, and windlatch retaining system.

Offset Hooks

Offset hooks allow for installation without gaps or spaces.

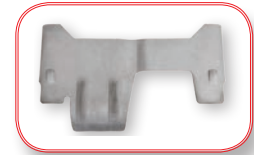

SF SERIES

SF Series Rhino Built Steel Scaffold Planks feature asymmetrical punched hole pattern corrugated work surface, offset hooks, and windlatch retaining system.

Aluminum Windlatch

Aluminum Windlatch ensures planks are secure, and prevents uplift



AU SERIES

AU Series Rhino Built Steel Scaffold Planks feature symmetrical punched hole pattern corrugated work surface, and electro-galvanized end caps.

End Caps

Corrosion resistant Electro-galvanized End caps

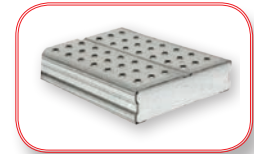

TAKE A LOOK

Innovative profile increases strength and lateral stability, decreasing flex and twisting.



Scaffold Deck Features

- 15 – Gauge Steel
- Corrugated Non-slip Surface
- Custom lengths available

Scaffold Depot

WORKPLATFORMS//

Manufactured in North America,

Scaffold Depot's line of Scaffold decks offer heavy-duty Aluminum I-beam side rails, one piece hooks, and Windlatch securing system. Scaffold Depot manufactures stock or custom sizes, with Plywood or Safety-Grip Steel top. Scaffold Depot also carries All Aluminum Scaffold Decks and Laminate Planks.



SLHD1024

Hatchdeck (One size only)

10' x 24" Hatch decks feature all aluminum ladders for safe, easy access to scaffolding levels above and below. Ladders utilize a latch to secure them out of the way during transport. Hatches can be closed when ladders are not in use, and opened from the top or bottom of deck.

Product Features

Aluminum Ladders provide safe, convenient access, and fold up and out of the way for transport and when not in use.



SDSG719

Safety Grip Deck

Safety Grip Decks incorporate a corrugated steel work platform, for high traction and maximum durability. Ideal in applications where wood is not appropriate or permitted, Safety Grip Decks will not rot or warp. Available in stock and custom sizes.

Corrugated Platforms

Corrugated Platform provides superior traction.

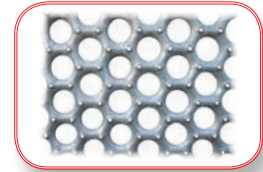

SD2007

Aluminum Scaffold Deck

All Aluminum Scaffold Decks are manufactured using high tensile, corrosion resistant aluminum, and feature corrugated work surface to increase traction. Wind latch securing system prevents uplift.

Windlatches

Heavy-duty Aluminum Windlatch secures deck safely in place, preventing any uplift.

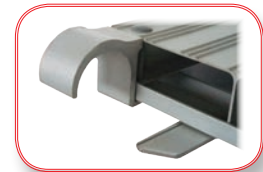

LAM

Laminate Scaffold Plank

Engineered Laminate Scaffold Planks are manufactured and field tested to ensure strength and consistency, provide reliable load capacities, and meet all applicable industry standards. More durable than solid wood planks, Engineered Laminate planks feature sealed and bonded veneers for enhanced weather protection.

Heavy Duty Mesh Grate

Expanded Steel Grating is heavy-duty expanded metal, made of steel plate, which is slit and expanded. Designed for use as lightweight, open steel flooring, it's ideal for catwalks, platforms and stair treads. Available in a variety of grades and sizes to meet a multitude of application requirements.



CLAMPS AND ACCESSORIES



TLFI CLAMPS // WEDGE CLAMPS

Scaffold Depot TLFi Clamps

Scaffold Depot carries the full line of Total Lock Fittings Inc. (TLFI) Scaffolding Couplers, now being used extensively through-out the Industrial and Commercial Sectors across North America and Europe.

TLFI TOTAL LOCK FITTINGS: WEDGE CLAMPS	PART #	SIZE	WEIGHT
Tube/Tube Right Angle Wedge Clamp	SDTTRA	48-48	3.25 lbs.
Tube/Frame Right Angle Wedge Clamp	SDTFRA	48-42	3.25 lbs.
Tube/Frame Swivel Wedge Clamp	SDTFSW	48-42	3.75 lbs.
Tube/Tube Swivel Wedge Clamp	SDTTSW	48-48	3.75 lbs.
End to End Outside Joiner	SDEETC	48-48	2.5 lbs.
Ledger Head Clamp	SDLEDCM	48-48	3 lbs.
Rosette Clamp	SDRC	48-48	1.75 lbs.
Spigot	SDSPGTCM	48-48	3.75 lbs.

Wedge Clamps

The wedge fastening system is industry proven to provide fast, secure connections, and reduce erection and dismantling costs. The TLFi line of wedge couplers includes Right Angle and Swivel Pipe clamps, for use with Steel or Aluminum Tube, Outside Joiners, Ledger Head Clamps, Rosette Clamps, and Spigots.

Product Features

- Low Maintenance
- Fast, efficient set-up and dismantling
- Corrosion resistant



SDTTRA/SDTFRA

Tube/Tube, Tube/Frame
Right Angle Wedge Clamp

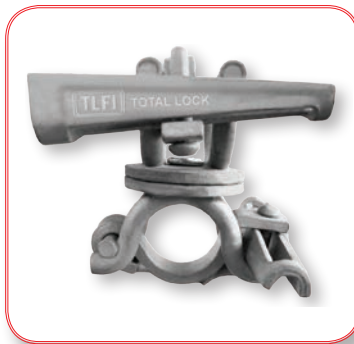

SDTFSW

Tube/Tube, Tube/Frame
Swivel Wedge Clamp



SDLEDCM

Ledger Head Clamp



SDEETC

End to End Outside Joiner

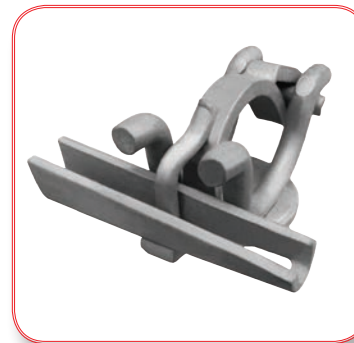

SDFHC

Tube or Frame Half Clamp

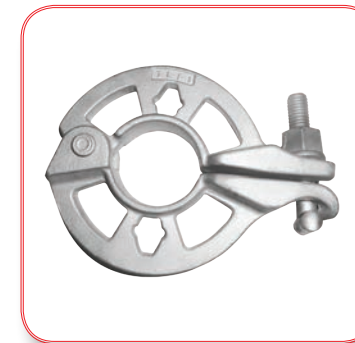

SDRC

Rosette Clamp



TLFI Certifications

TLFI Couplers are distortion and slip tested in accordance with CSA S269.2 "Access Scaffolding for Construction Purposes." They are also tested to European Standard EN 74-1:2005 (British Standard) BS EN 74-1:2005.

TLFI CLAMPS // BOLT CLAMPS

TLFI TOTAL LOCK FITTINGS: BOLT CLAMPS	PART #	SIZE	WEIGHT
Beam Clamp Swivel	SDSWBCM	48-42	3.5 lbs.
Beam Clamp Right Angle	SDFBCF	48-42	3.25 lbs.
Swivel Bolt Clamp	SDTTSWB	48-42	3 lbs.
Right Angle Bolt Clamp	SDTTRAB	48-42	3 lbs.

Bolt Clamps

Total Lock Fittings line of Bolt Clamps includes Right Angle and Swivel Pipe Clamps, appropriate for use with steel or aluminum tubing, and Right Angle and Swivel Beam Clamps, to create secure connections between Pipe and Beam.

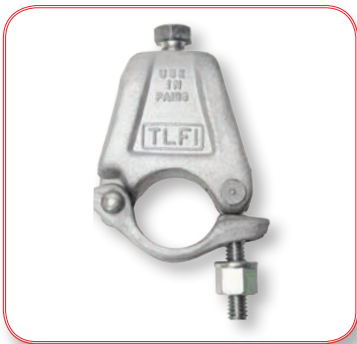

SDFBCF

Beam Clamp Right Angle

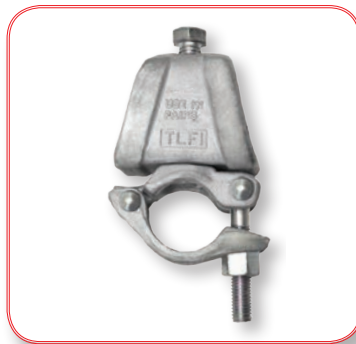

SDSWBCM

Beam Clamp Swivel



SDSPC

Saddle Pin



SDTTSWB

Swivel Bolt Clamp



SDTTRAB

Right Angle Bolt Clamp



SDSPGTCM

Spigot



About the TLFI Line

Years of development have gone into manufacturing a coupler comparable in strength and quality to the industry leader, which is priced more competitively, but sacrifices nothing in build quality or durability. Galvanized finish ensures corrosion resistance and low maintenance.

ALUMINUM BEAM // TUBING

Scaffold Depot Aluminum Beams

6.5" Aluminum Beam is available in lengths up to 28', with plastic or wood insert. High strength and non-corrosive, Aluminum beam's light weight allows for reduced strain on components and erectors. Compatible with the TFLI line of Right Angle Clamps, Swivel Clamps, V-clips, and Beam Clips.

Aluminum Beam Features

- Available in Stock and Custom Lengths and dimensions
- Line stenciled for traceability
- Individual piece to container-load quantities available
- Mill certificates on file

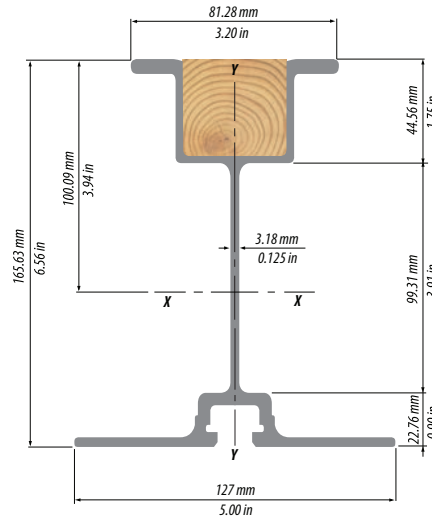

Aluminum Beam Accessories:

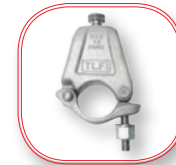

SDBC
RA & Swivel Forged
Beam Clamp

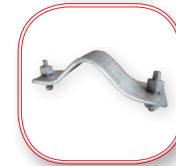

SDVC
V-clips

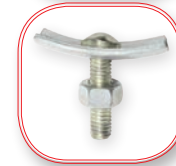

SDBC
Beam Clips

Scaffold Depot Aluminum Tubing

1.9" OD Aluminum Scaffold Tube is available in lengths up to 20'. Compatible with the full line of TFLI couplers, Aluminum Tube is a versatile and durable solution to many scaffold applications.



Aluminum Tube Features and Measurements

- Available in Stock and Custom Lengths
- Line stenciled for traceability
- Mill certificates on file
- Individual piece to container-load quantities available

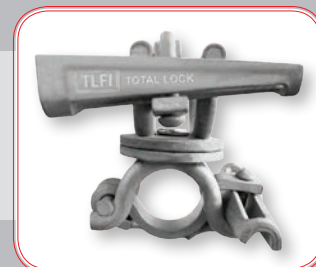

Compatible Clamps:

See pg. 16-17 for the full line of TFLI Couplers, ideal for use with 1.9" Scaffold Tube and Aluminum Beam



ACCESS FRAMES

SDSERIES//ARCHFRAMES

Scaffold Depots line of Access Frames

meet or exceed all applicable CSA and OSHA standards, and are ideal for rolling towers or building access applications. SD Series frames are compatible with our full line of scaffolding accessories, including Casters, Screwjacks, Side Brackets, Outriggers, Guardposts and Guardrails, as well as Stairs and TLF Wedge Couplers.

Available frame finishes:



Galvanized



Powder Coated

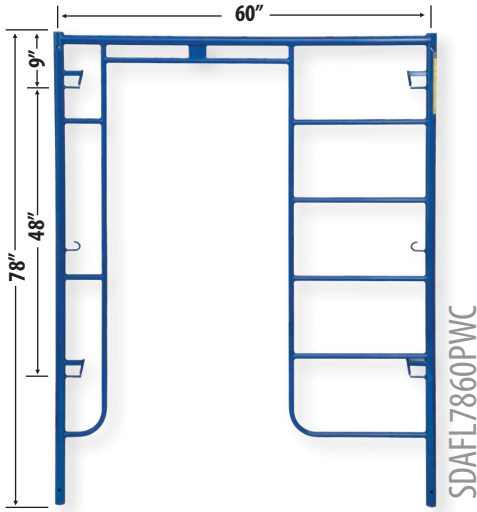

SDAFL7860PWC

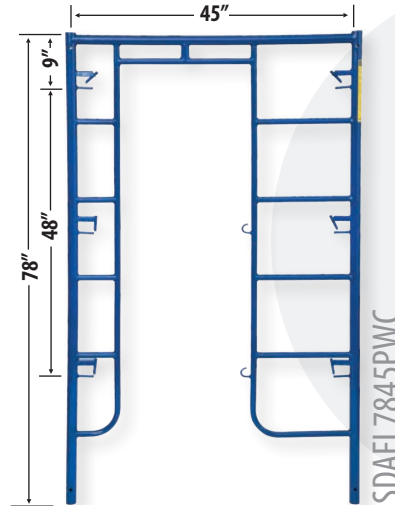

SDAFL7845PWC

PRODUCT FEATURES

78" High x 45" Wide Ladder Arch Frames



45" Wide Ladder Arch Frames require only 2 decks to complete your work platform, allowing for quicker set up, and lower costs then using a 60" wide frame. Perfect when installing Stucco or siding, condo restoration, or high rise maintenance.

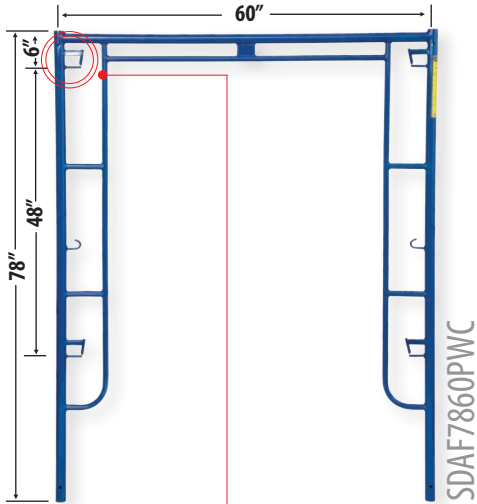

SDAF7860PCW

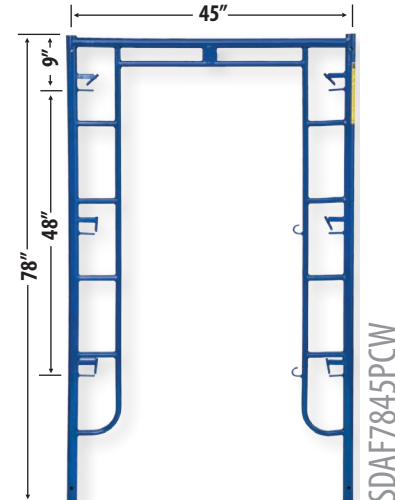

SDAF7845PCW

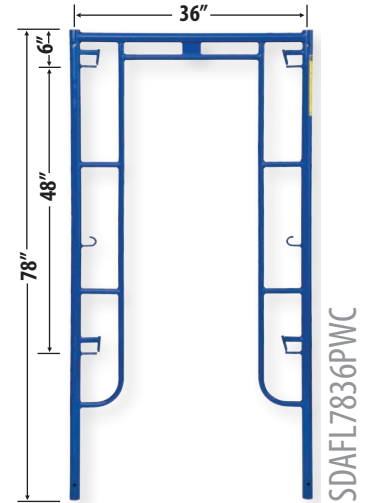

SDAFL7836PWC



TAKE A LOOK



Canada Lock pin allows for quick installation or dismantle of up to 2 Cross braces or guardrails.

ARCH FRAMES

MODEL	HEIGHT	WIDTH *	WEIGHT**	LOCK SPACE
SDAF7836	78"	36"	39.5 lbs.	6"
SDAF7845	78"	45"	43 lbs.	9"
SDAF7860	78"	60"	43.5 lbs.	6"
SDAFL7845	78"	45"	47 lbs.	9"
SDAFL7860	78"	60"	48 lbs.	9"

* Width measurement based on center to center of leg tube
 ** Weight does not include Coupling Pins or Spring Clips

SDSERIES//BOXFRAMES

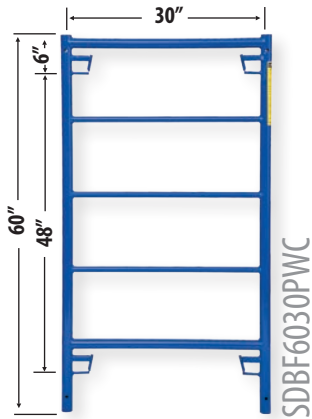

SD Series Features

- Headers and Legs for SD Series Frames are manufactured utilizing 1.69" Outside Diameter Steel Tubing, with 1.06" Outside Diameter rungs.
- Available in either Powder Coated or Galvanized finishes.
- 2 - 1 3/8" Outside diameter Coupling Pins with 1" Collar (SDCP) and 2 - Spring Retainers (SDSC) are required for stacking SD Series frames.
- Meets CSA and OSHA standards
- Fully coped joints ensure superior strength and durability

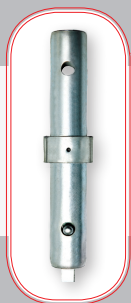
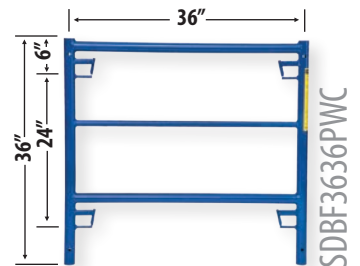
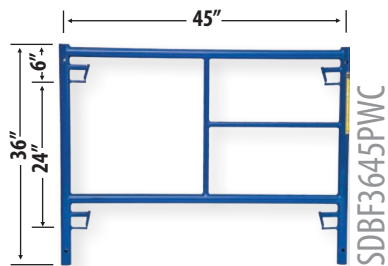
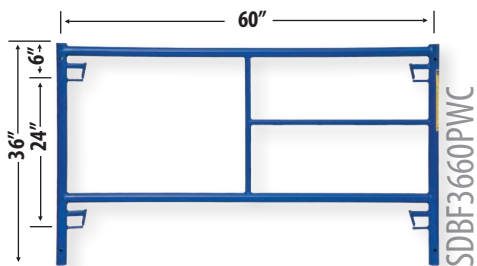
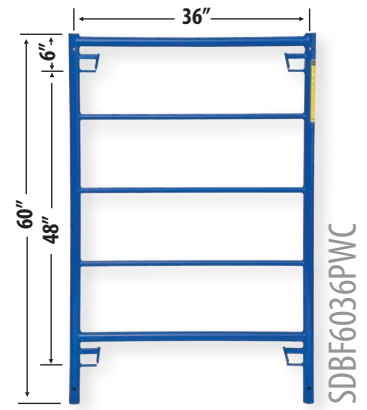
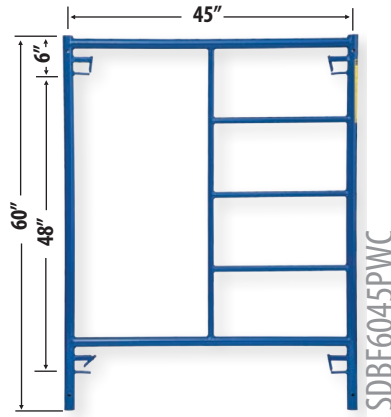
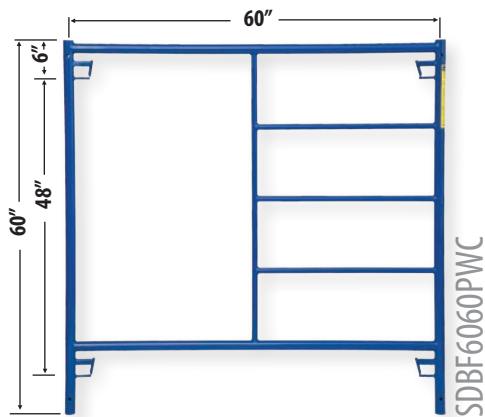

FRAME ACCESSORIES

Two - 1-3/8" Outside Diameter with 1" Collar Steel Coupling Pins are required when assembling scaffold. Available with or without Spring Retainers. (See pg. 14-17 for more accessories)

BOX FRAMES

MODEL	HEIGHT	WIDTH*	WEIGHT **	LOCK SPACE
SDBF6030	60"	30"	31.5 lbs.	48"
SDBF3636	36"	36"	22.5 lbs.	24"
SDBF3645	36"	45"	26.0 lbs.	24"
SDBF3660	36"	60"	30.5 lbs.	24"
SDBF6036	60"	36"	34.0 lbs.	48"
SDBF6045	60"	45"	33.5 lbs.	48"
SDBF6060	60"	60"	42.0 lbs.	48"

* Width measurement based on center to center of leg tube

** Weight does not include Coupling Pins or Spring Clips

ACCESSSTAIRS//STEEL

Access Stairs

Access Stair Units are available in either 78" or 60" high configurations, and feature corrugated steps and platforms for increased traction. All stair units are designed for use in a 7' long bay, and consist of 1 – stair section, 1- inside guardrail, and 1 outside guardrail. Guardrails are removable for various applications and easy transport. Inside ending rails are also available when required.

Fast & Efficient

Two End frames, two Cross-braces and one Stair Unit are all that is required per lift, making Stair Units a fast, efficient option for scaffold Access.

SDMST-760

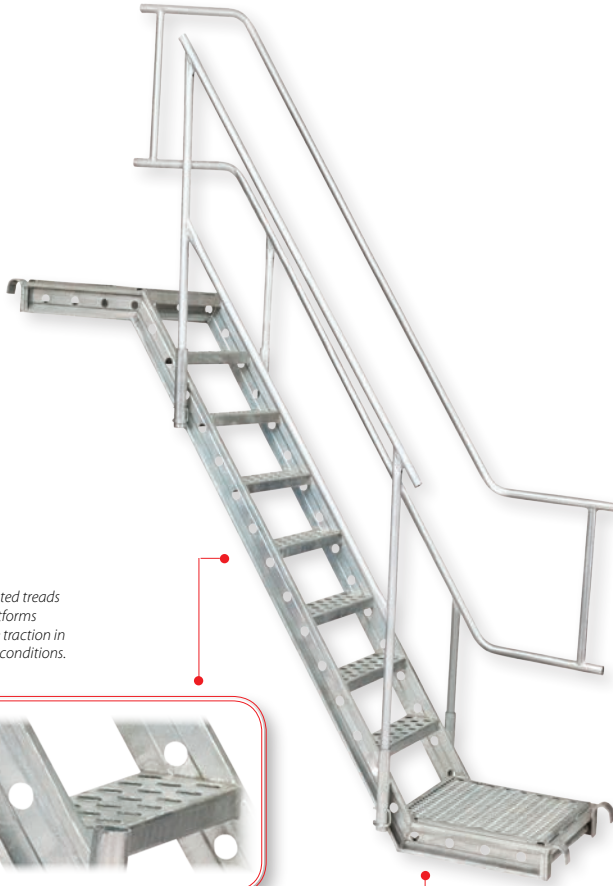

Corrugated treads and platforms increase traction in slippery conditions.



Available stair finishes:



SDMST-778

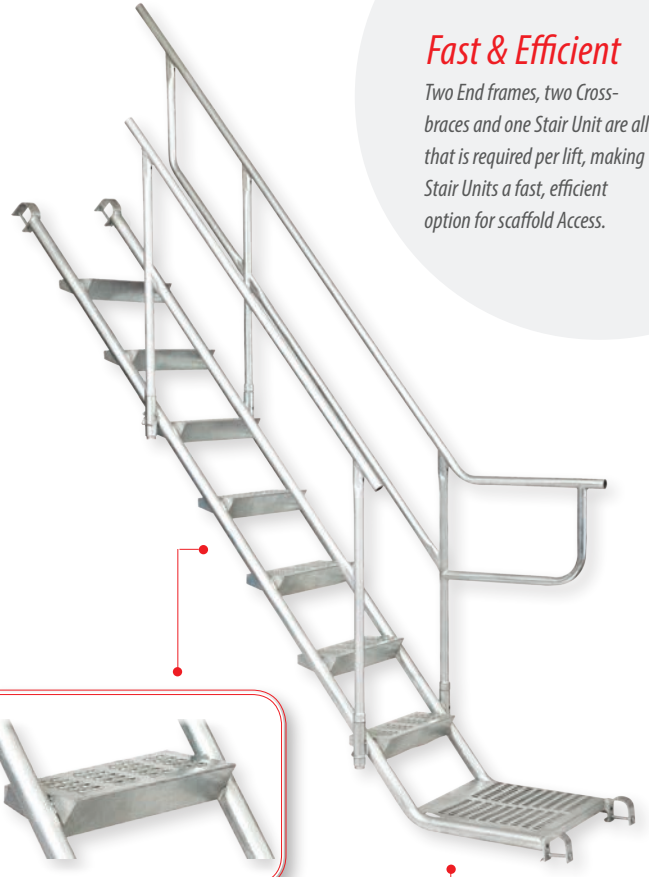

Available stair finishes:



MODEL	DESCRIPTION	WEIGHT
SDMST-778	78" Steel Stair	95 lbs.
SDMST-778-I	78" Stair Inside Rail	18 lbs.
SDMST-778-O	78" Stair Outside Rail	27 lbs.
SDMST-760	60" Steel Stair	125 lbs.
SDMST-760-I	60" Stair Inside Rail	18 lbs.
SDMST-760-O	60" Stair Outside Rail	27 lbs.

Access Stairs Features

- Quick set-up and disassembly.
- Heavy-duty, corrugated, non-slip steps increases traction in slippery condition.
- Lightweight Aluminum option reduces strain on erectors and components.



SDSTEB
Stair tower entry bar

ACCESSSTAIRS//ALUMINUM

Aluminum Access Stairs

Corrosion resistant and light weight, all aluminum stair sections reduce strain on erectors and components, allowing for easier stair tower erection and dismantle.

Scaffold Depot

SDAS778

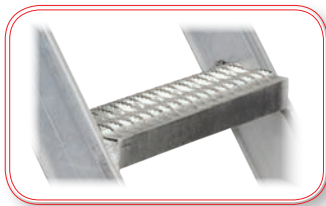
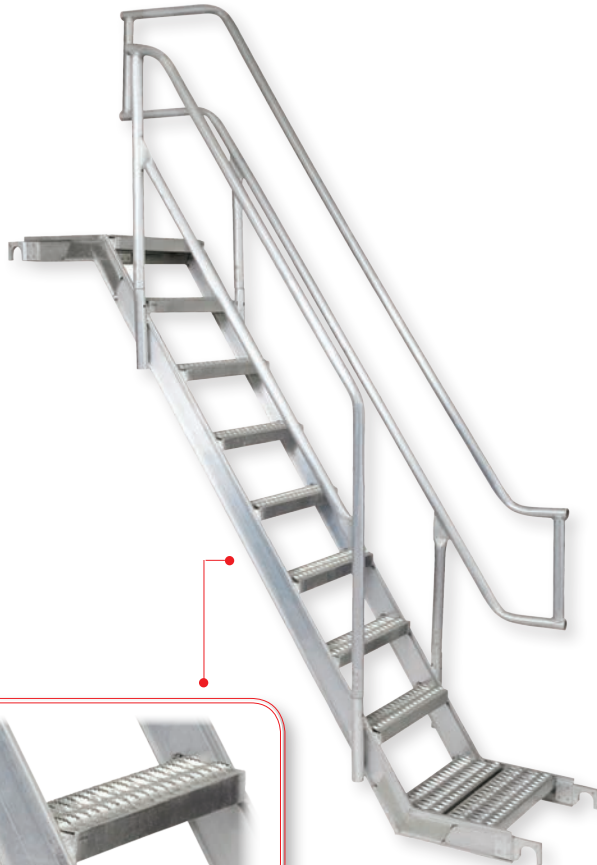

Available stair finishes:



SDAS760

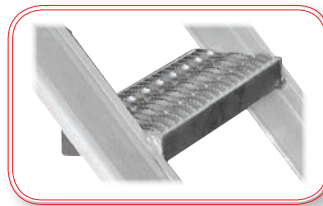
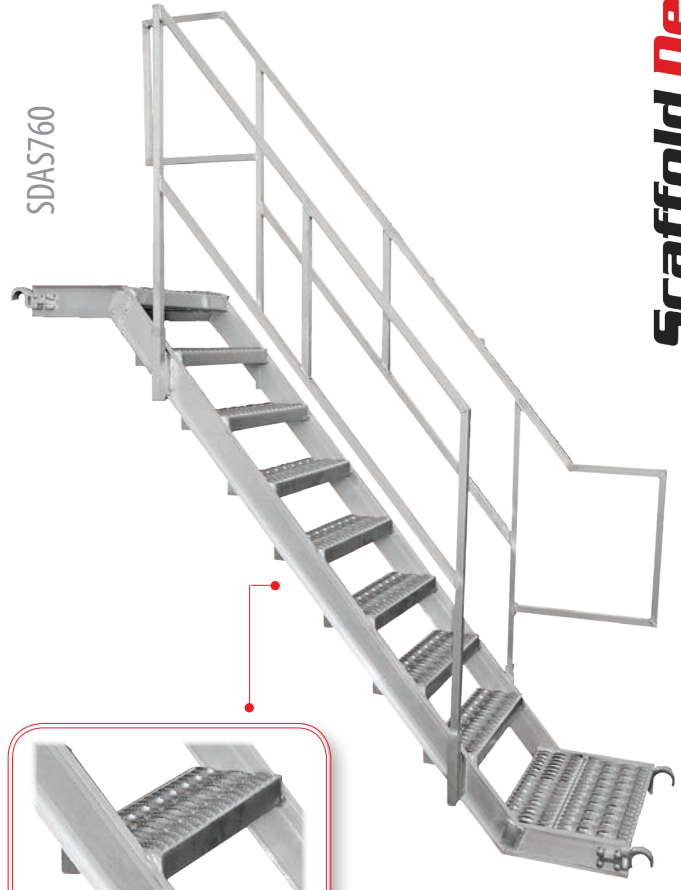

Available stair finishes:



MODEL	DESCRIPTION	WEIGHT
SDAS778	78" Aluminum Stair	54 lbs.
SDAS778-I	78" Aluminum Inside Rail	14 lbs.
SDAS778-O	78" Aluminum Outside Rail	21 lbs.
SDAS760	60" Aluminum Stair	22.5 lbs.
SDAS760-I	60" Aluminum Inside Rail	14 lbs.
SDAS760-O	60" Aluminum Outside Rail	21 lbs.

7' x 60" Stair Units

7' x 60" Stair Units are designed for use with 60"H x 60"W Box or Mason Frames. Height is based on the distance from the header of the bottom frame to the header on the top frame.

7' x 78" Stair Units

7' x 78" Stair Units are designed for use with 78"H x 60"W Arch Frames. Height is based on the distance from the header of the bottom frame to the header on the top frame.

ACCESSORIES//

Pins & Ties

Scaffold Depot carries a full line of Pins and Tie-ins to meet a multitude of erection requirements. Custom sizes available.

PINS & TIES

MODEL #	DESCRIPTION	WEIGHT
SDCP	Coupling Pin with 1" Collar	1 lbs.
SDCP1/8	Coupling Pin with 1/8" Collar	0.75 lbs.
SDSC	Spring Retainer	0.05 lbs.
SDJP	J-Pin	0.75 lbs.
SDWP	Wormpin	0.25 lbs.
SDLHK	Lag Hook	1.5 lbs.
SDSTH	Stucco Hook	1.15 lbs.
SDLG	Lag Screw	0.15 lbs.
SDLGB	Lag Bolt	0.75 lbs.
SDSTC	Stucco Clip	0.1 lbs.
SDVC	V-clip	1.75 lbs.
SDBC	Beam Clip	0.4 lbs.
SDMFSSP	Snap Pin	0.15 lbs

All pins are electro-galvanized to prevent rust and corrosion, and ensure long life and durability. Scaffold Depot is also able to manufacture different lengths and styles for custom applications.



SDCP
Coupling Pin with 1" Collar. 1" Collar coupling pins have holes 2.5" from the collar, allowing for the use of Spring Retainers, Wormpins or J-pins to secure connections.

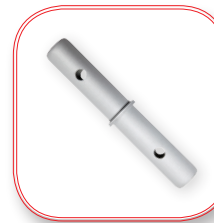

SDCP 1/8
Coupling Pin with 1/8" Collar. 1/8" Collar coupling pins have holes 2.5" from the collar, allowing for the use of Spring Retainers, Wormpins or J-pins to secure connections.



SDSC
Spring Retainers
Spring retainers provide a quick, easy way to ensure coupling pins are secured into frames.



SDLHK
Laghooks
Laghooks feature multiple holes to allow for various mounting options into aluminum tubing. 5mm holes drilled into the hook allows for tie-wire to ensure there is no uplift once installed.



SDSTH
Stucco Hooks.
Stucco Hooks are mounted into Aluminum Scaffold Tube to create any length tie-in.



SDLG
Lag Screws
4" Lagscrews are used in conjunction with Laghooks to tie directly into wood structures.



SDLB
Lagbolts
Lagbolts are available in lengths 2" – 8", and are used with 1/2" drop-in anchors to secure scaffolding to concrete structures.

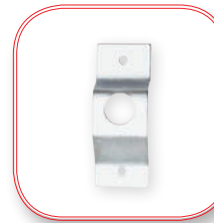

SDSTC
Stucco Clips
Stucco clips are used in conjunction with stucco hooks and aluminum tube to create a versatile, durable tie to wood joists.



SDBC
Beam Clips
Beam Clips are used in pairs to secure Aluminum Scaffold Beam to Post Shores.



SDWP
Wormpins
Wormpins are used to secure connections.



SDJP
Steel J-Pins
Steel J-pins feature a toggle retainer to allow for quick, secure installation and removal.

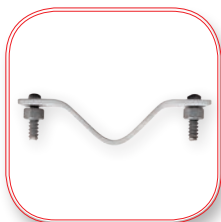

SDVC
V-clips
V-clips are used to secure Aluminum Scaffold Beam to Aluminum Tube or Ring System Scaffold.

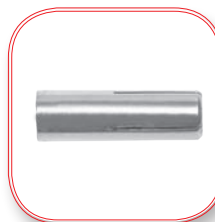

1/2DANC
Drop-In Anchor
Recommended for use with lag bolts when securing scaffolding to concrete structures.



SDMFSSP
Snap Pin
Used to secure caster on Multifunction Scaffold (SDMFS Pg. 33)

ACCESSORIES//

Crossbraces & Guardrails

Scaffold Depot carries a full line of Crossbraces and Guardrails, all manufactured using Pre-galvanized steel to ensure durability and rust resistance. Stock and custom sizes available.

Available brace finishes:



Pre-Galvanized

Scaffold Depot

CROSSBRACES

NAME	A	B	C	D	WEIGHT
<i>All Dimensions in Inches</i>					
4' x 2'	48	24	26-53/64	53-21/32	7 lbs.
4' x 4'	48	48	33-15/16	67-7/8	9 lbs.
5' x 2'	60	24	32-5/16	64-5/8	8.5 lbs.
5' x 4'	60	48	38-27/64	76-27/32	10 lbs.
6' x 2'	72	24	38	75-57/64	9.5 lbs.
6' x 4'	72	48	43-17/64	86-17/32	11 lbs.
7' x 2'	84	24	43-11/16	87-3/8	11.5 lbs.
7' x 4'	84	48	48-3/8	96-3/4	12.5 lbs.
8' x 2'	96	24	49-15/32	98-15/16	13 lbs.
8' x 4'	96	48	53-43/64	107-11/32	14 lbs.
10' x 2'	120	24	61-3/16	122-3/8	15.5 lbs.
10' x 4'	120	48	64-5/8	129-1/4	16.75 lbs.
7' x 28"	84	28	44-17/64	88-35/64	11.5 lbs.
10' x 28"	120	28	61-5/8	123-7/32	16 lbs.

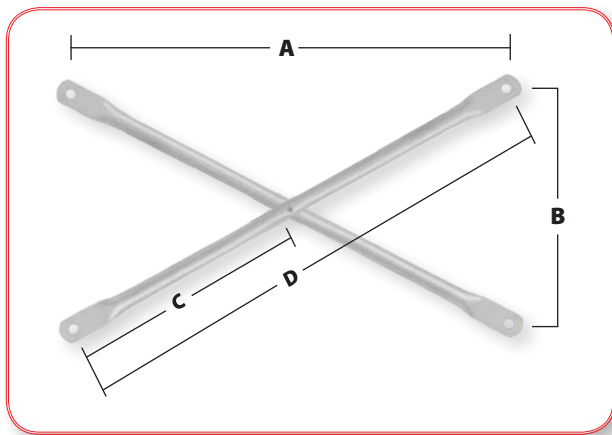

Crossbraces

Pre-galvanized Crossbraces far exceed painted rails for rust protection and durability.

GUARDRAILS

MODEL #	DESCRIPTION	WEIGHT
SDGR30	30" Guardrail	2 lbs.
SDGR36	36" Guardrail	2.5 lbs.
SDGR42	42" Guardrail	3 lbs.
SDGR45	45" Guardrail	3 lbs.
SDGR5	5' Guardrail	4 lbs.
SDGR7	7' Guardrail	5.5 lbs.
SDGR8	8' Guardrail	8 lbs.
SDGR10	10' Guardrail	10 lbs.

Guardrails

Scaffold Depot guardrails are manufactured using corrosion resistant pre-galvanized steel, and utilize simple punched hole design for tool less set up and dismantle.

GUARD-POST

MODEL #	DESCRIPTION	WEIGHT
SDGPG	Steel Guardpost with Hooks	7 lbs.

Guardpost

Dual Hooks provide mounting points for top and mid-rails, and allow for efficient erection and disassembly.

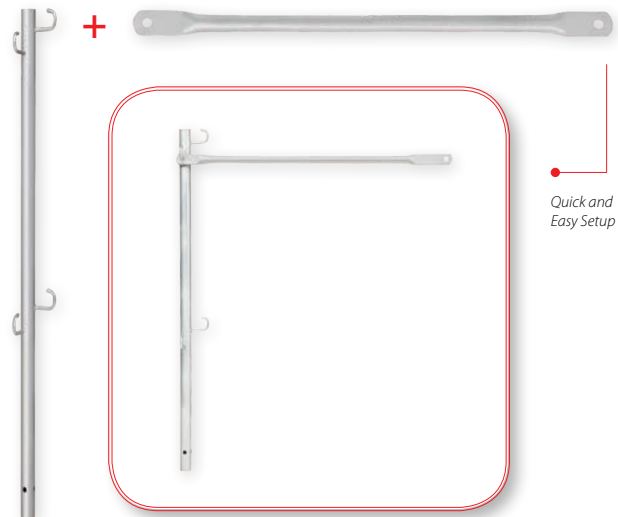

Quick and Easy Setup

Goosers

Plan braces secure a scaffold bay diagonally across the base, ensuring towers stay square, while horizontal braces are used to add stability directly across bays.

PART #	DESCRIPTION	WEIGHT
SDDG105	10' x 5' Diagonal Goosier	14.5 lbs.
SDDG75	7' x 5' Diagonal Goosier	12.5 lbs.
SDHG105	10' Horizontal Goosier	13 lbs.
SDHG75	7' Horizontal Goosier	10 lbs.

Available finishes:



Pre-Galvanized



SDCB

Ideal for rolling and stair towers, Scaffold Depot only carries braces manufactured from corrosion resistant, pre-galvanized steel.



SDSB30G

Bolt Lock ensures secure connections

ACCESSORIES//

Side Brackets

Side Brackets are available in 20", 30", and 40", and in either Hot-dipped Galvanized finish or Powder coated.

Available finishes:



Galvanized



Powder Coated

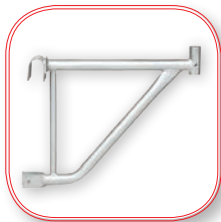

SDEB20G
20" End Bracket

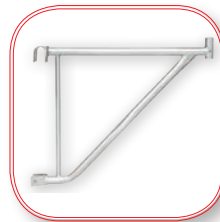

SDEB30G
30" End Bracket

PART #	DESCRIPTION	WEIGHT
SDEB20	20" End Bracket	11.5 lbs.
SDEB30	30" End Bracket	15.5 lbs.
SDSB20	20" Side Bracket	11.5 lbs.
SDSB30	30" Side Bracket	14.5 lbs.
SDSB40	40" Side Bracket	19 lbs.

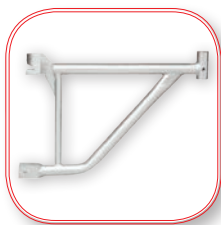

SDSB20G
20" Side Bracket

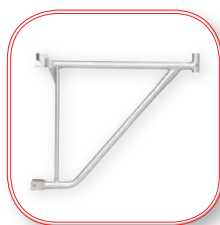

SDSB30G
30" Side Bracket

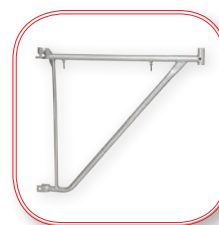

SDSB40G
40" Side Bracket

Outriggers

Outriggers are used to widen the base of a scaffold tower, allowing extra height to be added once the 3:1 ratio has been met. Available in galvanized and powdercoated, Scaffold Depot Outrigger's feature a dual bolt clamp fastening system to ensure stability.

Available finishes:



Galvanized



Powder Coated

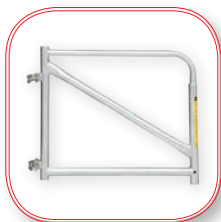

SDOR
30" Outrigger

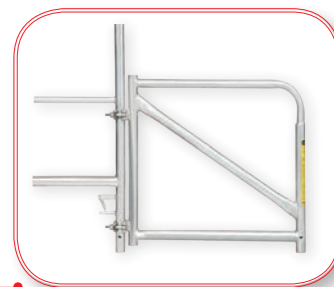

Dual bolt
clamp
fastening
system

PART #	DESCRIPTION	WEIGHT
SDOR30	30" Outrigger	20 lbs.

Endstops & Swinggates

Endstops are available in Powder Coated or Hot-dipped Galvanized Finish, and eliminate fall hazards through Arch Frames, while Swing Gates open to allow easy access to levels, but lock closed to ensure safety.

Available finishes:



Galvanized



Powder Coated

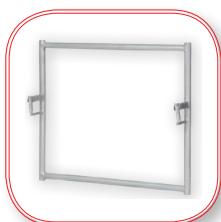

SDEST
36" Endstop

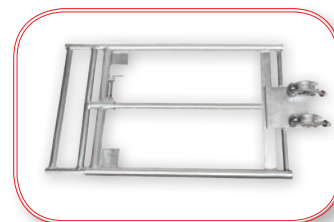

SDSGA
Swing gate

PART #	DESCRIPTION	WEIGHT
SDEST36	36" Endstop	6 lbs.
SDSGA	Swing Gate Adjustable	15 lbs.
SDSGF	Swing Gate Fixed	12 lbs.

ACCESSORIES//

Casters

Scaffold Depots line of 5", 8", and 12" HD casters all feature dual locking brakes to prevent swiveling or rolling while towers are in use, and are manufactured to high standards to ensure safety and durability.



SDMFSC5
5" Multi-Function Scaffold Caster
Multi-Function Scaffold Swiveling Caster with Dual Brake, utilize a square peg design with pin hole at 2.5"



SDCWB12HD
12" Caster with Plate HD
1200 lb Capacity caster with plate is compatible with System Adapter or Adapter Screwjack.

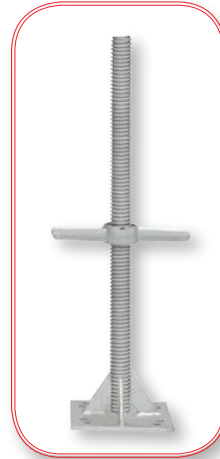

SDAJHD
Adapter Jack



SDCW8
8" Caster with Brake.
500 lb Capacity Swiveling Casters feature dual locking brake.

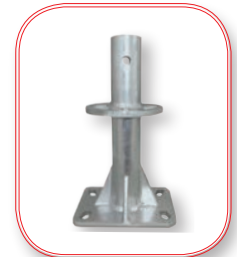

SDABHD
Adapter Base

Scaffold Depot

Screwjacks & Baseplates

Scaffold Depot carries a full line of Galvanized Base plates and adjustable Screwjacks, Casterjacks, and U-heads.



SDSWSJBP24
24" Swivel Screwjack with 5.5" x 5.5" Base



SDCJWS
24" Casterjack with socket

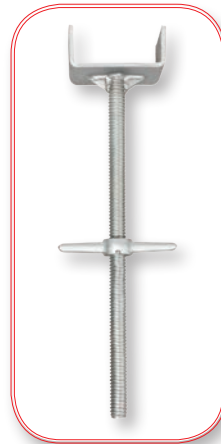

SDUHSJ
24" U-head Screwjack

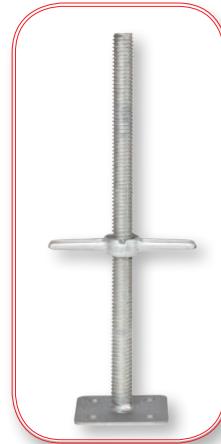

SDSJBP24
24" Screwjack with 5.5" x 5.5" Base plate

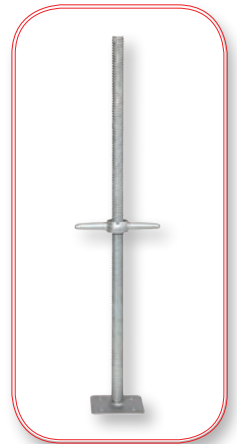

SDSJBP36
36" Screwjack with 5.5" x 5.5" Base plate



SDBPF
Fixed Base plate with 5.5" x 5.5" Base



SDBPSW
Swivel Base plate with 5.5" x 5.5" Base

MODEL #	DESCRIPTION	ADJUSTMENT	WEIGHT
SDBPF	Fixed Base Plate	n/a	2.5 lbs.
SDBPS	Swivel Base Plate	n/a	3 lbs.
SDSJBP24	24" Screwjack with Base plate	18"	12.5 lbs.
SDSJBP24	24" Screwjack with Base plate - Hollow	18"	8.5 lbs.
SDBP36	36" Screwjack with Base plate	24"	16.5 lbs.
SDSWSJ24	24" Swivel Screwjack with Base plate	18"	15 lbs.
SDCJWS	24" Casterjack with Socket	18"	11 lbs.

TOEBOARDS & PULLEYS //

Steel Toeboards

Toeboards are used to ensure tools, building materials, and debris do not fall from work platforms. Scaffold Depot carries a full line of Steel Toeboards, ranging in length from 0.65M – 3.05M, and can also manufacture custom sizes when required.

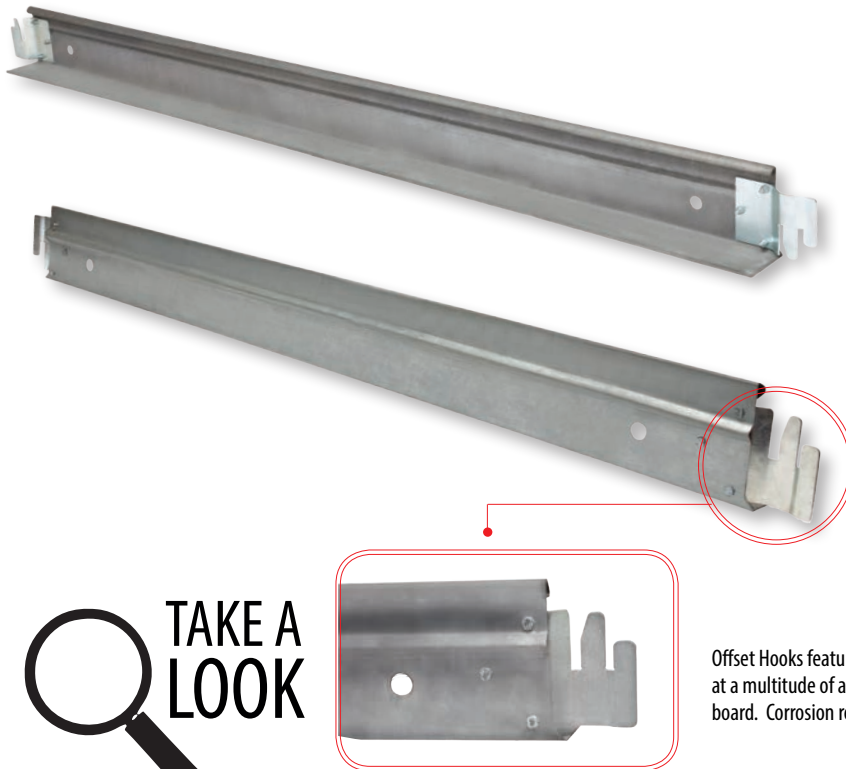

Toe Board Features

- Offset hooks
- Tool-less installation and dismantle
- Corrosion resistant

PART #	DESCRIPTION	WEIGHT
TBH065	0.65M Toe Board with Hook	6 lbs.
TBH088	0.88M Toe Board with Hook	6.5 lbs.
TBH115	1.15M Toe Board with Hook	10.5 lbs.
TBH157	1.57M Toe Board with Hook	14 lbs.
TBH213	2.13M Toe Board with Hook	18 lbs.
TBH305	3.05M Toe Board with Hook	25.5 lbs.
TBH36	3' 6" Toe Board with Hook	8 lbs.

Offset Hooks feature multiple interlocking options, so toeboards can be installed at a multitude of angles, without leaving a gap between the work platform and board. Corrosion resistant electro-galvanized finish ensures durability.

Pulleys

Scaffold Depot stocks 12" Gin Pulleys, ideal for safe passing of scaffolding components up to higher levels, or down during dismantle.



PART #	DESCRIPTION	WEIGHT
PW	Pulley Wheel	8 lbs.
SDPWHA	Pulley Hanger	25 lbs.

PW
Durable powder coated finish ensures durability and maintenance free use.



SDPWHA
Pulley Wheel Hanger

MULTIFUNCTION//SCAFFOLD

Scaffold Storage

Stackable cages and racks help to maximize yard and site storage, allowing for more efficient use of space. Proper storage also helps ensure accurate, secure shipping, and increases speed of loading and unloading.



SDLRGC
Steel Cage

Steel cages can store up to 500 couplers, and are ideal for small components. Easy stacking allows for maximum storage capabilities, and fast, secure loading when shipping.



SFSRG
Storage Rack with Posts

Ideal for storing and shipping SD Ring System Scaffold, stackable racks feature removable posts to reduce space required when not in use. Available in galvanized or powder coated finish.

Scaffold Depot

Multi-Function Scaffolding

Multi-function Scaffolds are ideal when temporary work platforms are required in tight spaces. Only 30" wide, Multi-function Scaffolds allow access through doorways, hallways and narrow walk-ways, and can be set up on stairs or other uneven surfaces. Scaffold Depot also carries guardrail systems, and outriggers, all in heavy-duty Powder coated finish.

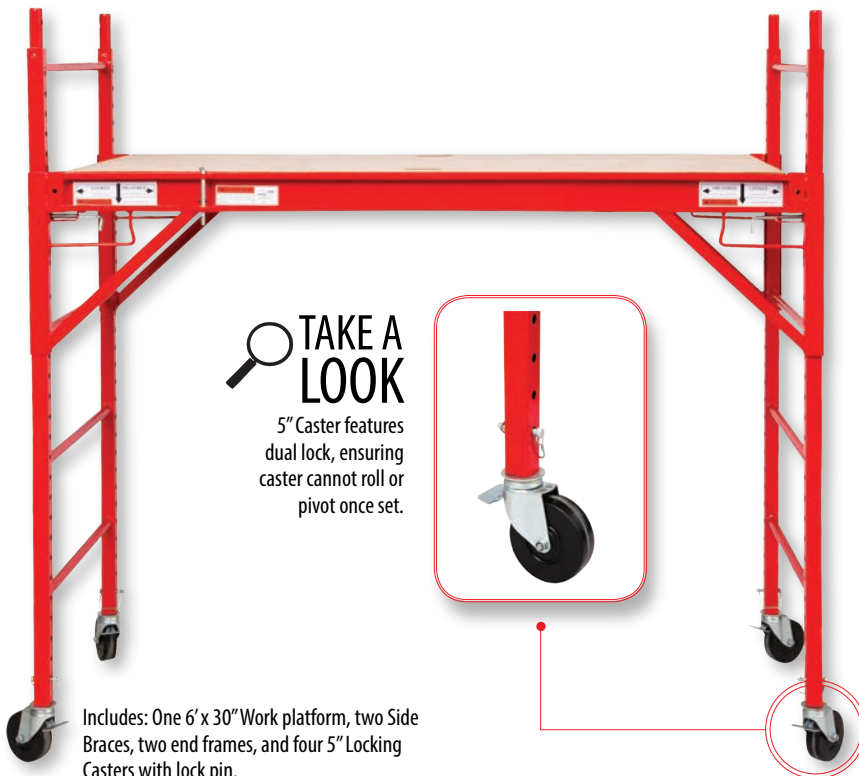

TAKE A LOOK

5" Caster features dual lock, ensuring caster cannot roll or pivot once set.

Includes: One 6' x 30" Work platform, two Side Braces, two end frames, and four 5" Locking Casters with lock pin.

PART #	DESCRIPTION	WEIGHT
SDMFS	6' Multi Function Scaffold	144 lbs.
SDMFSGR	Multi-Function Scaffold Guardrail	81 lbs.
SDMFSOR	18" Multi-Function Scaffold Outrigger	6.5 lbs.
SDMFSOR32	32" Multi-Function Scaffold Outrigger	20 lbs.

Multi-function Scaffold Guardrails feature locking swing-gate for easy access.

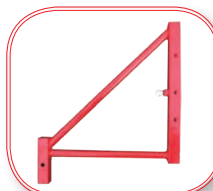

Outriggers allow for multiple units to be stacked, allowing for access to difficult to reach areas.



SHORING//

Post Shores

Scaffold Depot's line of Steel Post shores are hot-dipped galvanized for maximum life span and durability. Available in sizes #1 - #5



- Universal bolt pattern in top and bottom plates allow for secure fastening
- Simple, fast height adjustment by pinning equally spaced holes
- Quick release device saves time during stripping
- Galvanized, cast fine adjustment collar ensures accurate height
- All adjusting hardware is affixed to the Post shore, preventing lost or missing components
- Heavy gauge, high strength steel tubing utilized for inner and outer pipes
- Post shores only support vertical loads
- Install with either end up

PART #	DESCRIPTION	WEIGHT
PSM001	#1 Steel Post Shore	41 lbs.
PSM002	#2 Steel Post Shore	46 lbs.
PSM003	#3 Steel Post Shore	51 lbs.
PSM004	#4 Steel Post Shore	59 lbs.

Product Features

- Minimal maintenance required
- Quick and easy handling
- Heavy-duty locking pin

Debris Net

Lightweight debris netting is manufactured from high density polyethylene monofilament, and features eyelets at close intervals of 10cm for easy installation.



Debris Net Features

- Knitted high density polyethylene (HDPE) scaffold net
- Ideal for indoor and outdoor applications
- Available in Green and Blue
- 150' x 10' Roll
- UV treated

Surrey, BC - Head Office



#4 -9659 192 St.
Surrey, BC
V4N 4C7

Phone: +1 604.513.9222
Toll Free: +1 888.595.6111
Fax: +1 604.513.9292

Edmonton, AB

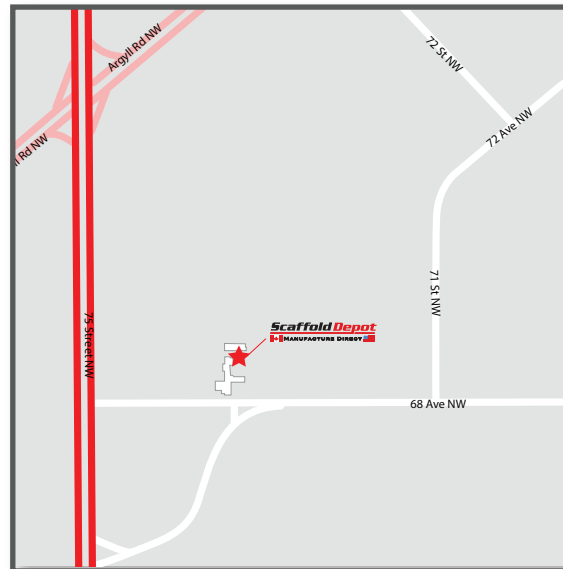

7320 68 Avenue
Edmonton, AB
T6B 0A1

Phone: +1 780.485.0934
Toll Free: +1 888.595.6111
Fax: +1 780.485.0359

Scaffold Depot

www.scaffolddepot.com

Ladders & Painter's Planks

Painter's Planks

Aluminum Painters Planks feature easy grip rungs, as well as molded handles for easy transport and durability. Slip resistant aluminum deck with raised tread spikes increases traction, and planks with 6" or larger extrusions have reinforced side channels

*Guardrail systems are available for all sizes.
For more information please see our
Complete Ladder Line Catalog*

- **Safety Yellow Molded Handles**
Impact resistant polypropylene handles designed for easy transport and rugged durability. Available on 4", 5", and 6" stages. Cast rail end caps available on 7" stages.
- **Easy Grip Rungs**
Rungs on each end provide wide, easy to grip handles for pulling or carrying stages.
- **Slip Resistant Decking**
"Sure-Foot" aluminum decking with raised tread spikes for slip resistant surface. (Fall through decking optional-separate order)

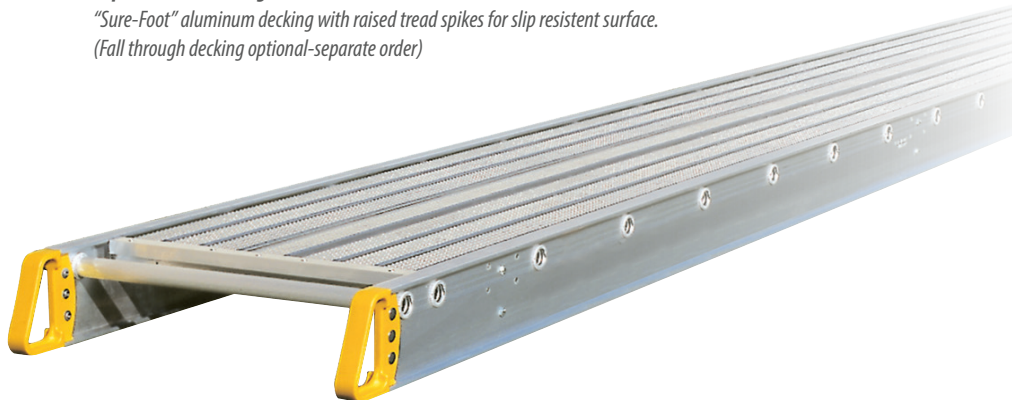



CONTACT US

Toll Free: 1-888-595-6111
Fax: 1-888-595-8333

Head Office:
#4 9659 192nd Street
Surrey, BC, Canada V4N 4C7
Tel: +1 604 513 9222
Fax: +1 604 513 9292

Edmonton Office:
7320 68 Avenue
Edmonton, AB, Canada T6B 0A1
Tel: +1 780 485 0934
Fax: +1 780 485 0359

www.scaffolddepot.com

